

**FläktGroup**<sup>®</sup>

AIRTREND Ltd  
Predstavništvo u Beogradu  
Kumanovska 14, 11000 Beograd  
Tel: 011/3836886, 3085740  
Faks: 011/3444113  
e-mail: [gobrid@eunet.rs](mailto:gobrid@eunet.rs)  
web: [www.airtrend.rs](http://www.airtrend.rs)

# PUR (A, B, C, D)

INSTRUCTION FOR VARIABLE SPEED  
WITH WIRING DIAGRAM , EMX-R  
ROTOR SIZE 125-250 TECHNICAL DATA



## VARIABLE SPEED-CONTENT PUR (A, B, C, D) ROTOR SIZE 125-250

Content	Page
<b>General description</b> .....	3
Control- and operation equipment for variable speed .....	3
Heat recovery .....	3
Cooling recovery .....	3
Description .....	3
.....	
Technical data.....	3
Motor unit.....	3
Control unit .....	3
Defrosting.....	3
Cooling recovery .....	3
Soft start.....	3
Enthalpy.....	3
<b>Safety regulations</b> .....	4
When installation.....	4
When in operation.....	4
When dismantling and scrapping .....	4
Advantages with EMX-R exchanger .....	4
<b>Operation, indication</b> .....	5
Operation indication/built-in functions .....	5
Automatic purging operation.....	5
Rotation monitor (DIP-switch 4) – model E.....	5
<b>Protection</b> .....	6
Test switch .....	6
Protection of the control unit .....	6
Mounting.....	6
Sensor for rotation – model E.....	7
Connection.....	7
When turning off .....	7
Recommendations for EMC.....	7
<b>Control unit</b> .....	8
<b>Wiring diagram</b> .....	9
<b>Speed regulator</b> .....	10
Speed regulator.....	10
Selection of max speed .....	10
<b>Fault functions</b> .....	11
Priority switch/defrosting/manual control .....	11
Manual control with 10 kOhm .....	11
Parallel connection.....	11
Cooling recovery, summer/winter switch .....	11
Analogue outsignal (only model E).....	11
Potentiometer with low resistance, 100 Ohm – 5 kOhm (only model E) .....	11
<b>Speed regulator</b> .....	12
Motor measuring.....	12
<b>Fault tracing</b> .....	13
<b>Technical Data</b> .....	14
<b>Motor Dimensions</b> .....	15

## VARIABLE SPEED-CONTENT PUR (A, B, C, D) ROTOR SIZE 125-250

### CONTROL- AND OPERATION EQUIPMENT FOR VARIABLE SPEED

#### HEAT RECOVERY

The speed of the heat exchanger is controlled continuously via temperature sensor for either constant supply air temperature, constant room temperature or constant exhaust air temperature.

#### COOLING RECOVERY

If the temperature of the outdoor is higher than the temperature of the exhaust air, the rotor speed can be regulated to maximal speed for cooling recovery.

#### DESCRIPTION

The electronic speed regulator is specially suited for control of a rotary heat exchanger.

The equipment consists of an enclosed control unit and a motor unit. The control unit and the motor unit are test run and adjusted when delivered.

No adjustments are needed when commissioning. The control unit is fed with 1-phase alternating voltage, 50-60 Hz, 220-240 V  $\pm 15\%$ .

#### TECHNICAL DATA

Table 1. Control unit and motor

Rotor Size	Control- and operation equipment (EMX-R)			
	Operation	Current A	Motor capacity W	External fuse insert
125-150	EMX-R-25	1.3	100	10 AT
151-250	EMX-R-35	1.5	160	10 AT

#### MOTOR UNIT

The motor is coiled special for the purpose, why it cannot be replaced with a standard motor. Rotation direction can be altered with DIP-switch No 6.

The protection form of the motor: IP54

Min ambient temperature: -30 °C

Max. ambient temperature: +40 °C

Maintenance: Maintenance free

#### CONTROL UNIT

Voltage: 1 x 220-240 V  $\pm 15\%$

Frequency: 50-60 Hz

Min. ambient temperature: -30 °C

Max. ambient temperature: +40 °C

Capsule class: IP54

Alarm outlet:

Variable contact, max. 230 VAC, 5 A may load the switch.

#### Control signals:

0-10 V, 2-10 V, 0-20 V (DC or phase cut)

0-20 mA, 4-20 mA or via potentiometer 0-10 k $\Omega$

The control signals are galvanic separated from the net.

#### DEFROSTING

Defrosting is initiated by the difference pressure switch which measures the pressure drop above the heat exchanger on the exhaust air side, see page 9. The control unit down regulates the rotor of the heat exchanger to 5 % of max. speed.

#### COOLING RECOVERY

When cooling recovery is initiated by the difference thermostat PUMZ-21, the rotor of the heat exchanger is regulated up to max speed, see page 9.

#### SOFT START

The soft start implies that the rotor is accelerated to max. speed in 15-35 seconds.

#### ENTHALPY

The sensors are connected to an external switch, which in turn is connected to terminal block 51-52. This function is only available from model E.

## VARIABLE SPEED-CONTENT PUR (A, B, C, D) ROTOR SIZE 125-250

### WHEN INSTALLATION

- Read the whole instruction before installation and commissioning.
- The installation should be performed by authorized personnel.
- General terms and regulations for installation and operation of electrical plants should be considered.
- Take necessary precautions for protection against person- and machine damage that should be taken in accordance with local terms and regulations.
- The operation system EMX-R exchanger is intended for steady installation.
- Cables may not be connected to or taken out as long as the supply voltage is on.
- Check that the equipment is correctly connected before it is taken into operation, see instructions in the chapter mounting/connection.
- Faults occurred due to faulty installation.

### WHEN IN OPERATION

- Measuring in the control unit when in operation may only occur on the connection terminal blocks. NOTE! Take utmost precaution.
- The units may not be opened or dismantled when in operation.

### WHEN DISMANTLING AND SCRAPPING

- The capsule for the control unit is made of aluminium and sheet steel. The material should be handled and recycled in accordance with applicable laws.
- The circuit card contains small amounts of tin and lead which should be handled and recycled in accordance with applicable laws.
- The motor is made of copper, plastic, aluminium and iron. The materials should be handled and recycled in accordance with applicable laws.

### ADVANTAGES WITH EMX-R EXCHANGER

- Simple to handle since no breaking in or adjustment of the operative system is needed.
- Robust motor unit since no gear is needed.
- The motor has rotation direction free of choice.
- Constant torque over the whole speed area.
- Short circuit safe between the motor phases and between motor phases and earth.

- Soft start and soft stop minimize the mechanical wear.
- INTRASENS<sup>®</sup>, elektronik rotor level sensing which guarantees that the motor, independant of load, always keep the set speed of the control signal.
- Built-in electronical motor protection eliminates the need for external motor protection.
- Capsule class IP54 protects against dirt and dampness.
- High efficiency which gives low operation costs.

The control system is available in two variants, S and E where the E-model has an extra circuit card for extended functionality. Built-in functions in model S are:

- Automatic purging operation
- Rotation monitor – electronic built in
- Alarm relay
- Test-switch
- Priority switch/defrosting
- Cooling recovery for external difference thermostat

Model E has besides the in model S built-in functions also:

- Speed display - the speed of the rotor in speed/min, when the external rotation sensor is connected.
- Analogue out signal 0-10 V/0-20 mA proportional to the speed of the motor.
- Cooling recovery when external temperature sensor are connected.
- Inlet for potentiometer with low resistance, 100 Ohm - 5 kOhm.
- Prepared for serial communication.

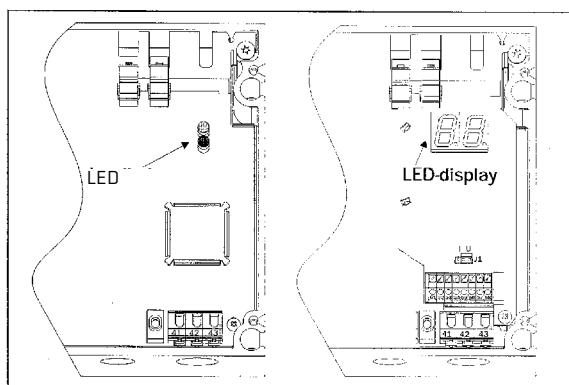

Fig. 1. Operation indication is indicated with two LED in model S and with LED-display in model E.

## VARIABLE SPEED-CONTENT PUR (A, B, C, D) ROTOR SIZE 125-250









### OPERATION INDICATION/BUILT-IN FUNCTIONS

Indication is indicated with two LED, one green and one red, on model S and with LED-display on model E in accordance with the following:

Table 2. Operation indication model S with integrated electronic sensor.

Green	Slow flashing – Purging mode/Low control signal.
	Rapid flashing – Operation, the motor rotates continuously.
	Lit for two seconds – Magnet passing rotation sensor.
Red	Lit - RotoSens measures the load on the motor during acceleration.
	Lit or flashing LED indicates alarm, see also the chapter on troubleshooting.

Table 3. Operation indication model E with external rotation sensor mounted.

	Purging mode. Low control signal.
	The speed of the rotor in rpm. At start a speed is displayed according to the gear ratio rotor/motor = 1:25. After 2 pulses from the rotation monitor, the correct speed of rotation of the rotor is displayed. Range 0.2-99 rpm.
	RotoSens is selected using the DIP-switch (4) and with no rotation sensor connected.
	Lit for two seconds when the magnet passes the rotation sensor.
	RotoSens measures the load on the motor during acceleration.
	Summer operation/heat recovery on cooling.
	No rotation monitor - DIP 4 in the OFF position and jumper 31-32.
	An alarm is indicated by the letter F followed by a number. See also the chapter on troubleshooting.

### AUTOMATIC PURGING OPERATION

When the control signal is low, <1.5 V by 0-10 V, the operation system enters purging operation. The motor axle rotates 2 revolutions every 10:th minute when purging operation, which corresponds to ca 30 degrees on the heat exchanger rotor. This slow rotation does not develop any essential additional heat, but only serves to keep the rotor clean. Most often the rotor sealings keep the rotor steady, but if the rotor sealings are not in close contact against the rotor and if the air flow is not at an angle against the rotor, the air flow can make the rotor rotate. To then prevent involuntary heat recovery a restraining moment is activated in the motor to keep the heat exchanger rotor steady. When the operation system is in purging operation for the first time after power is on, the restraining moment is not activated, since many rotors do not need any active restraining moment to stand still. A rotor which needs restraining moment will then slowly start to rotate. The operation system will then immediately slow down the speed to zero and will then always add a restraining moment when the rotor should stand still. The operation system has now learnt which rotors need restraining moment and which do not need it. The restraining moment is 50 % higher than the torque required for operation just before it should stand still. This implies that the restraining moment can vary after one rotation revolution. If the restraining moment is activated and you take hold of the drive belt and turn the rotor by hand the restraining moment will increase steplessly. Restraining moment is generated by a current that runs in one of the phases of the motor, the higher restraining moment required, the higher current will be. This current-generates a sound which increases with increased current. An over load protection built-in into the control unit, which constitutes of three i2t-protections, one from each motor phase, protects the motor even when the restraining moment is activated.

### ROTATION MONITOR (DIP-SWITCH 4) – MODEL E

Two different rotation monitors can be selected. The first, RotoSens™, which is an integrated electronic rotation monitor, and secondly a rotation monitor using a rotation sensor. RotoSens uses the motor as the sensor. By allowing the control unit to measure the load on the motor, you can determine whether the drive belt has broken. When the drive belt has broken the motor load will be low. As the rotors which rotate very easily also give a low load on the motor, it is necessary to also measure the load during acceleration - you then get a measurement of the rotor's moment of inertia. After 2 minutes of operation at a low load, a load measurement is made during acceleration. If the drive belt is broken an alarm is given, if it is undamaged the load measurement during acceleration is repeated again after 24 hours.

## VARIABLE SPEED-CONTENT PUR (A, B, C, D) ROTOR SIZE 125-250

In cleaning mode, measurement during acceleration is made once every 24 hours. The rotation monitor with sensor has a magnet fitted on the periphery of the rotor. The magnet activates the sensor once every revolution. Should, for example, a belt break and the rotor stops, the pulses cease and an alarm is given. The time until the alarm is given is speed dependent and is 24 seconds at max. speed, 20 minutes at min. speed and about 8 hours in purge mode alarm relay, the motor does not stop with an alarm. For operations without the rotation monitor with sensor or the rotation monitor RotoSens the DIP-switch 4 is set to "OFF" and a jumper is fitted between terminals 31 and 32.

### TEST SWITCH

The control unit is equipped with a test switch underneath the lid, between the terminal blocks 37 and 41. In setting "ON" the motor soft starts and speeds up to max. speed independent of other signal sources. In setting "OFF" (downwards) the test switch is off. The test switch can also be used to run the motor on max. speed if for example external control signal is not available.

### PROTECTION OF THE CONTROL UNIT

The control unit is equipped with over and under current control. When respective limit values are above or under limits allowed for mains power supply, the control unit is disconnected and the motor is stopped. When the mains power supply returns to normal value the motor will automatically start up. The control unit has a built-in motor protection, which protects against over load, that is why external motor protection is not needed. When over load the current to the motor is broken. To restart the operation system the mains power supply to the control unit should temporary be disconnected for at least 5 seconds. A built-in short circuit protection protects against short circuit between the motor phases and earth.

Table 2. Operation indication model S with integrated electronic sensor.

Protective function	External alarm with alarm relay	Restart	Alarm reset
Supply fault, over voltage	Yes, immediately	Automatic	Automatic
Supply fault, under voltage			
Pre-alarm, rotation monitor	No	Motor not stopped	1)
Rotation monitor	Yes		
Pre-alarm, motor protection/overload	No	The system tries to reset three times	Automatic
Motor protection/overload	Yes, immediately	Manual, disconnect and reconnect power supply	Manual, disconnect and reconnect power supply
Short circuit			

<sup>1)</sup> RotoSens – manual, disconnect and reconnect the power supply.  
Rotation monitor with sensor – automatic.

### MOUNTING

Both the motor and the control unit are mounted in the casing of the heat exchanger. In that way they take up no space outside and are well protected during transport. To be built-in inside the casing of the rotor is also advantageous from disturbance point of view (EMC).

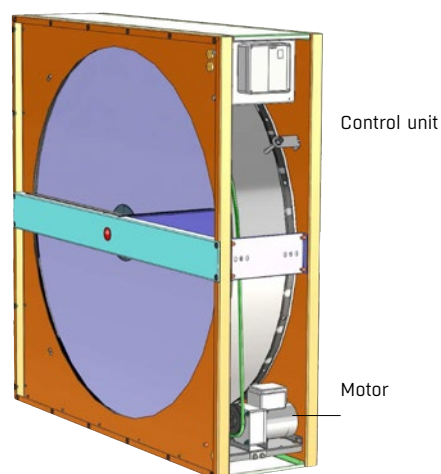

Fig. 2. Rotor with control system

## VARIABLE SPEED-CONTENT PUR (A, B, C, D) ROTOR SIZE 125-250

### SENSOR FOR ROTATION – MODEL E

The magnet to the rotation sensor is screwed tight on the periphery of the heat exchanger rotor. If the wheel around the rotor is magnetically conductive the magnet must be isolated from the casing. The rotation sensor is mounted in such a way that the magnet passes at a distance of 3-5 mm, see below. Rotation sensor with magnet can be ordered separate.

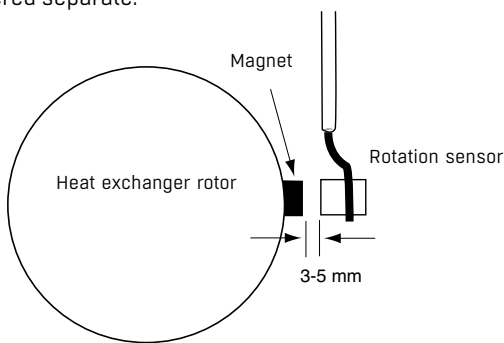

Fig. 3. Mounting of rotation sensor.

### CONNECTION



**WARNING!**

Left over current is left for 1 minute after breakage of mains power voltage.

The motor is delivered with steady connected motor cable to simplify the mounting of the operation system. The cable is 2.5 m for EMX-R-25/35M. Separate outer fuse on 10 AT should always be installed. Internal in the operating system there is no fuse. An electrical motor protection is integrated in the control which the whole time controls the motor. The control is protected against short circuit in the motor. Safety isolating switch is installed between mains power and control. When the mains power is disconnected an alarm is initiated on the loss of power supply.



**WARNING!**

Power switch may not be connected between motor and control.

### WHEN TURNING OFF

When it is desired to shut off the heat exchanger rotor i.e. during the night, this can be performed by a relay in serial with the control signal, which breaks away the signal to control signal terminal block 33. Thereby alarm is avoided due to mains power failure. Of course to the same function also the control signal can be regulated down to its lowest value.

### RECOMMENDATIONS FOR EMC

In order to fulfil the european EMC-directive 89/336/ECC regarding electromagnetic compability the following must be taken into consideration:

The motor cabel should be placed as close to the heat recovery wheel as possible. If a part of the wire is left over it is gathred to i.e. an 8. The surface inside the wire should be made as small as possible. A tape or bundling tape can be used for this.

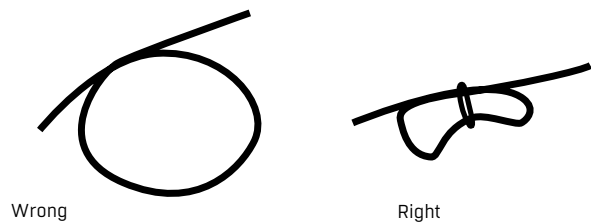
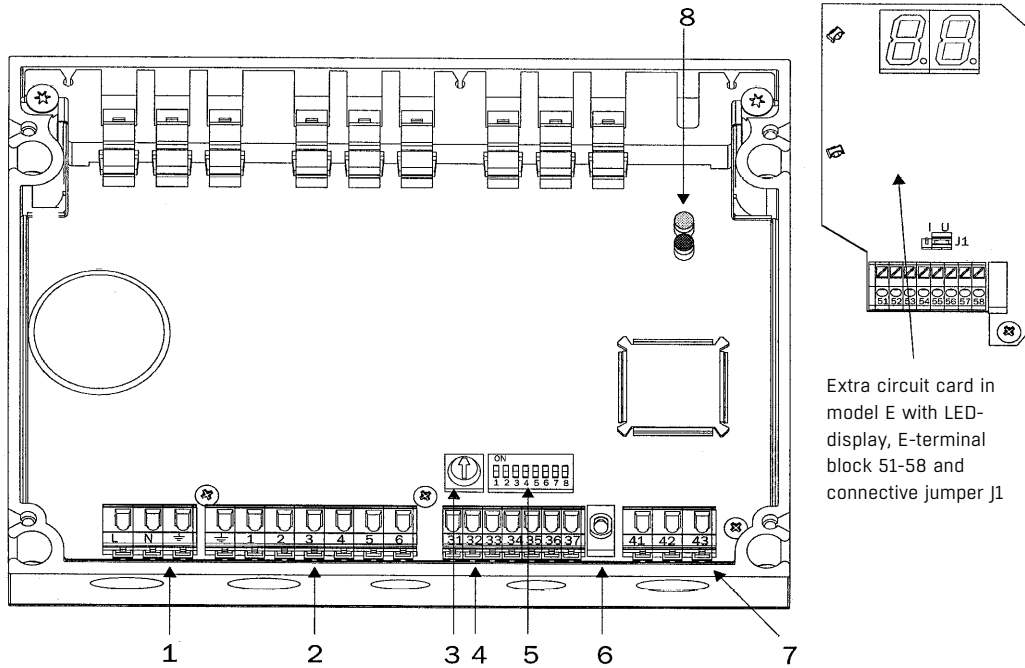

Fig. 4. If a part of the motor wire is left over it is gathered in such a way that the surface inside it is as small as possible.

There are no demands for special EMC-lead-throughs. In all EMX-R exchangers there is a built-in EMC-filter. This filter is suited to the steady mounted motor wire.

## VARIABLE SPEED-CONTENT PUR (A, B, C, D) ROTOR SIZE 125-250



No	Denomination
1	Mains power terminal block
2	Motor terminal block
3	Priority potentiometer
4	Control signal terminal
5	DIP-switch
6	Test-switch
7	Alarm terminal block
8	Operation indication, model S

Fig. 5. Placement of connection terminal blocks.



### VARIABLE SPEED-CONTENT PUR (A, B, C, D) ROTOR SIZE 125-250

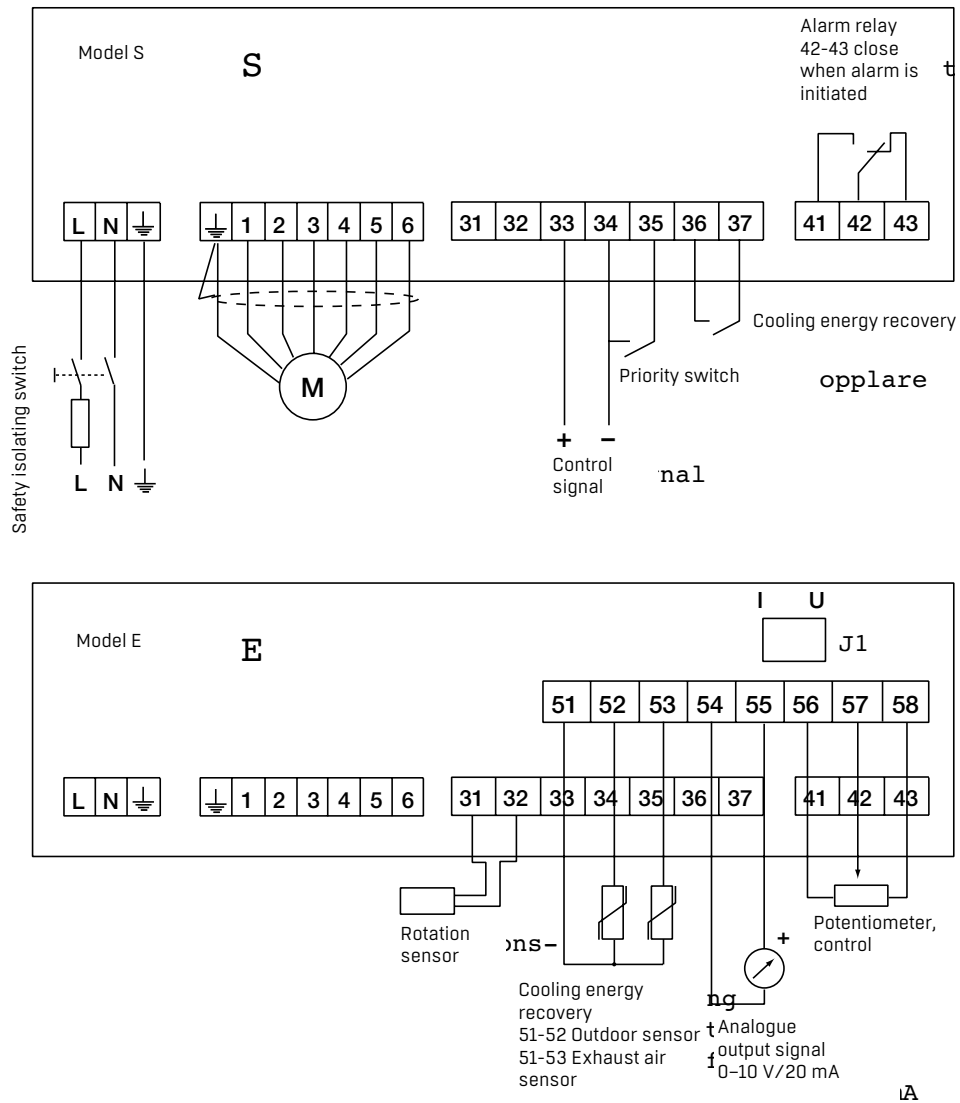

Fig. 6. Wiring Diagrams for Model S and Model E

## VARIABLE SPEED-CONTENT PUR (A, B, C, D) ROTOR SIZE 125-250



### WARNING!

The DIP-switches may only be adjusted when the mains power supply has been broken.

### SPEED REGULATOR

With DIP-switch 5 in the control unit two speed regulators can be selected. The one regulator is softer and is used when elastic belts such as belts with round cross section, flat belts and elastic V-belts are mounted. DIP-switch 5 should then stand in "OFF" position. The other regulator is faster and stiffer, it is intended for stiff V-belts. DIP-switch 5 should then stand in position "ON".

If the stiff regulator is not enough at max. speed=100 % for even operation, a yet stiffer and faster regulator can be selected by placing the DIP-switches 5 and 7 in position "ON" and DIP-switch 8 in position "OFF".

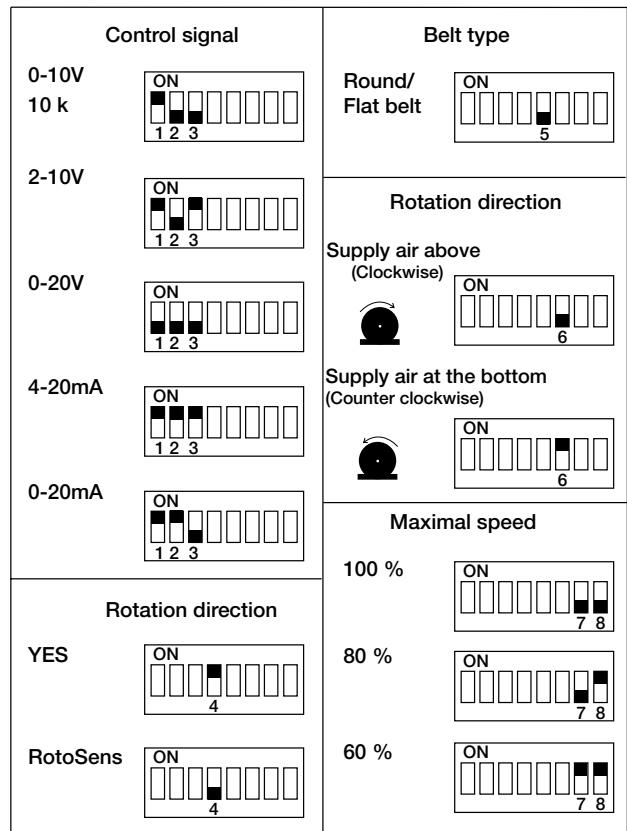
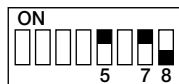

Fig. 7. Setting of DIP-switch.

### SELECTION OF MAX SPEED

Maximal speed can be limited to 80 % (200 revolutions/min) or 60 % (150 revolutions/min). This function is foremost intended to be used for rotors smaller than ca 1.3 m, when you wish to limit the max. speed and/or when using larger belt pulleys.

## VARIABLE SPEED-CONTENT PUR (A, B, C, D) ROTOR SIZE 125-250

### PRIORITY SWITCH/DEFROSTING/ MANUAL CONTROL

A preset speed can be ordered by potentialfree closing of the priority inlets 34-35. When terminal block 34 is connected to terminal block 35, the speed is controlled by the priority potentiometer, which is placed by the DIP-switches in the control. The priority switch has higher priority than the summer/winter switch (only model E) and the control signal.

The switch can be used when cleaning of the rotor, defrosting with external difference pressure switch and for manual control of the speed.

### MANUAL CONTROL WITH 10 kOhm

The operation system can simply be controlled manually with a 10 kOhm potentiometer which is connected in accordance with the figure.

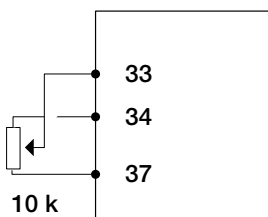

Fig. 8. Connection potentiometer in control unit.

### PARALLEL CONNECTION

When parallel operation of several rotary heat exchangers from a control signal/sensor, each heat exchanger rotor must be equipped with an operation system of its own (motor and control unit). The control signal is connected to the first operation system in accordance with the connection regulation, other control units are connected through terminal block 33 respective 34 on the other control units are connected to terminal block 33 respective 34 on the first control unit.

The DIP-switches in the first control unit are set in accordance with DIP-switch. In the other control units DIP 1 and 3 are set in accordance with setting of DIP-switch, while DIP 2 always is set in accordance with the below:

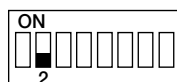

Fig. 9. Setting of DIP 2.

The control units initiates alarm individually. The alarm outlets can be connected parallelly or in serial to obtain group alarm. Model E can also use the analogue outsignal to control other operative system. Terminal block 54(-) respective 55(+) is connected to 34(-) respective 33(+). The DIP-switches are set in accordance with settings of DIP-switch in on all control units.

### COOLING RECOVERY, SUMMER/WINTER SWITCH

The operation drop when the outdoor air temperature is above the exhaust air temperature is what is called cooling recovery. By running the rotating heat recovery on max. speed, a cooling efficiency on the incoming air is obtained. By using an external regulator which has this built-in function, is the simplest way to obtain the cooling recovery function. EMX-R recovery is then controlled via the control signal, ex. 0-10 V. If i.e. external regulator is already installed one can obtain cooling recovery function by connecting a separate difference thermostat directly to EMX-R exchanger, terminal block 36-37.

Model E has a built-in difference thermostat. This makes it possible to connect 2 NTC-sensors, 2000 Ohm ex. EGL 511, one in the outdoor air duct and one in the exhaust air duct directly to EMX-R exchanger, terminal block 51-53. When the exhaust air is colder than the outdoor air the rotor rotates with max. speed, cooling recovery.

When the exhaust air is warmer than the outdoor air, the normal case, the speed is controlled by the control signal, heat recovery.

### ANALOGUE OUTSIGNAL (ONLY MODEL E)

0-20 mA or 0-10 V proportionally to the speed of the motor. Full indication, 20 mA alternatively 10 V, is always obtained at the selected max. speed (60, 80 or 100 % of the highest possible speed of the motor). 0-20 mA or 0-10 V signal is selected with the jumper J1 behind the control terminal block 51-58.

### POTENTIOMETER WITH LOW RESISTANCE, 100 Ohm – 5 kOhm (ONLY MODEL E)

When control from potentiometer with a total resistance value between 100 Ohm and 5 kOhm 3 wires are connected to terminal block 56-58. The DIP-switches 1-3 are set as torque signal 0-10 V.

## VARIABLE SPEED-CONTENT PUR (A, B, C, D) ROTOR SIZE 125-250



### WARNING!

Left over current is left for 1 minute after breakage of the mains power supply.

### Maintenance

Motor and control unit is normally maintenance free. Though it is advisable to regularly check that the wiring is free of faults and that all fastening screws are correctly tightened.

### Fault tracing

Check that the installation is correctly carried out, i.e. that the wires are correctly isolated, no loose wires etc. and that the DIP-switches are correctly set.



### WARNING!

Test and the DIP-switches may only be adjusted after the mains power has been broken.

It is always possible to test run the operation system with the TEST switch under the lid at terminal 37, see Fig. 5. The switch has two steady positions, in upward position the motor speeds up to max. speed independent of control signal and in downward position the speed is controlled by the control signal. If the motor does not accelerate to max. speed or follows the control signal, check the DIP-switches 1-3 and 7 and 8.

If the heat exchanger rotates in the wrong direction DIP-switch 6 should be adjusted. When exchange of the control unit the whole capsuled box with circuit cards should be exchanged.

### MOTOR MEASURING

Break the mains power supply. Loosen the motor wirings from the control. Measure the motor resistance between 1-2, 3-4 and 5-6. It must be:

EMX-R-25M; 5-15 Ohm





EMX-R-35M; 5-15 Ohm







The resistance may not differentiate more than 2 Ohm between the phases for 25/35M.

Also check isolation between 1-3, 1-5, 3-5, 1-earth, 3-earth and 5-earth.

## VARIABLE SPEED-CONTENT PUR (A, B, C, D) ROTOR SIZE 125-250

Table 5. Fault tracing

Alarm indication			Cause of fault/measure
S	E	Fault	
Green LED is flashing slowly		Purging/low control signal	Check EMX-R control unit by running the operation system with the test switch at terminal block 37. The motor should be accelerated up to max. speed. If the motor accelerates on the test switch the fault is external. If 0-10 V (2-10 V) can be measured between 33(+) and 34 (-)? Are the + and - leads transposed?
Red and Green LED are flashing fast		Pre-alarm, rotation guard	The operation system has switched to a softer speed regulator because the motor shaft violently jerks. Check that the drive belt is whole, that it is tensioned and does not slip in the pulley.
Red LED is flashing fast		Rotation guard	The heat exchanger rotor is standing still; check the drive belt. The rotor is rotating; check that the rotation sensor is correctly mounted, see section mounting. When the magnet passes the sensor on model S and higher point on model E green LED is lit for two seconds, if not exchange rotation sensor.
Red LED is lit and green LED is flashing fast		Pre-alarm, overload/motor protection	The motor protection has been initiated due to too high load. After a cooling time of 10 minutes the system restarts automatically. If the over load protection is initiated 3 times within 120 minutes the operation system is closed off, see more overload, (F5).

Alarm indication			Cause of fault/measure
S	E	Fault	
Red LED is lit		Over load/motor protection	The motor protection has been initiated due to too high load. Check that the motor wirings are correctly connected, see section connection. If the operation system runs longer periods with too high load F5 is initiated. Check that the rotor does not seize and that the rotor and belt pulley do not have too large diameter. If the fault remains, carry out motor measuring, see below. Exchange the motor if it is defect. If the motor is free of fault, exchange the control unit.
No LED is lit	—	Mains power supply is missing	Check that 230 VAC ±15% is connected to the mains power supply terminal block.
Red and green LED are alternating flashing slowly		Over current	The mains power supply is exceeding 264 VAC
		Under current	The mains power current is below 196 VAC
Red and green LED are alternating flashing fast		Earth connection in the motor	Break the mains power supply, check the connection of the motor wiring and that correct motor is connected. If the fault remains, perform motor measuring see below. Exchange the motor if it is defect. If the motor is free of fault, exchange the control unit.
Red LED is flashing slowly		Short circuit in the motor	
		Break in the motor	

## VARIABLE SPEED-CONTENT PUR (A, B, C, D) ROTOR SIZE 125-250

Table 6. Technical data

Function	EMX-R		
	25	35	
Output data	Rotation speed [rpm]	5-250	
	Torque [Nm]	4	6
	Power [W]	100	160
	Direction of rotation	Selectable	
	Purging operation	Built-in function	
	Motor protection	Built-in function	
	Soft start and stop (S)	25/25	35/35
	Alarm output	Alternating contact, max 5 A 230 VAC	
Input data	Supply voltage	220/230/240 VAC $\pm 15\%$ , 50/60 Hz	
	Current [A]	1.3	1.7
	Control signal	0-10 V, 2-10 V, 0-20V phase cut, 0-20 mA, 4-20 mA, 10 kOhm potentiometer	
General	Protection class	IP 54	
	Weight, controller [kg]	1.7	
	Weight, motor [kg]	8	11
	Connectors	1 pc M 12 and 4 pc M 16	
	Ambient temperature	-30 - +40° C	
	Tachometer	INTRASENS® (Electronic tachometer, tachometer cable are not needed)	
	EMC, Emission	EN 50081-1	
	EMC, Immunitet	EN 50082-2	

Table 7. The drive system's operating conditions using different control signals

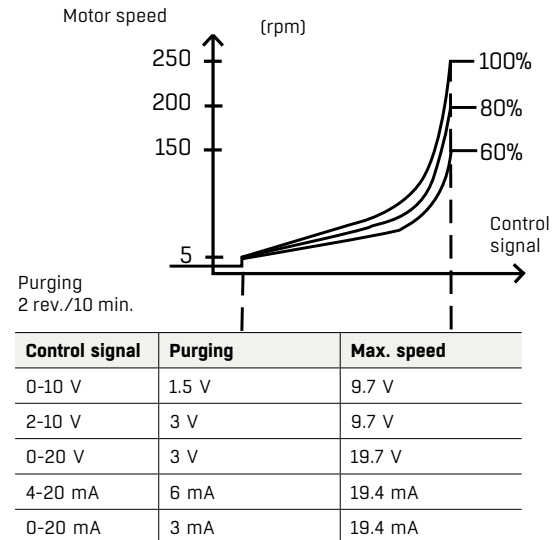

The drive system has a built-in function that gives a linear relationship between the control signal and the efficiency of the heat exchanger rotor, rather than having the speed of rotation proportional to the control signal. This provides good conditions for a stable temperature control.

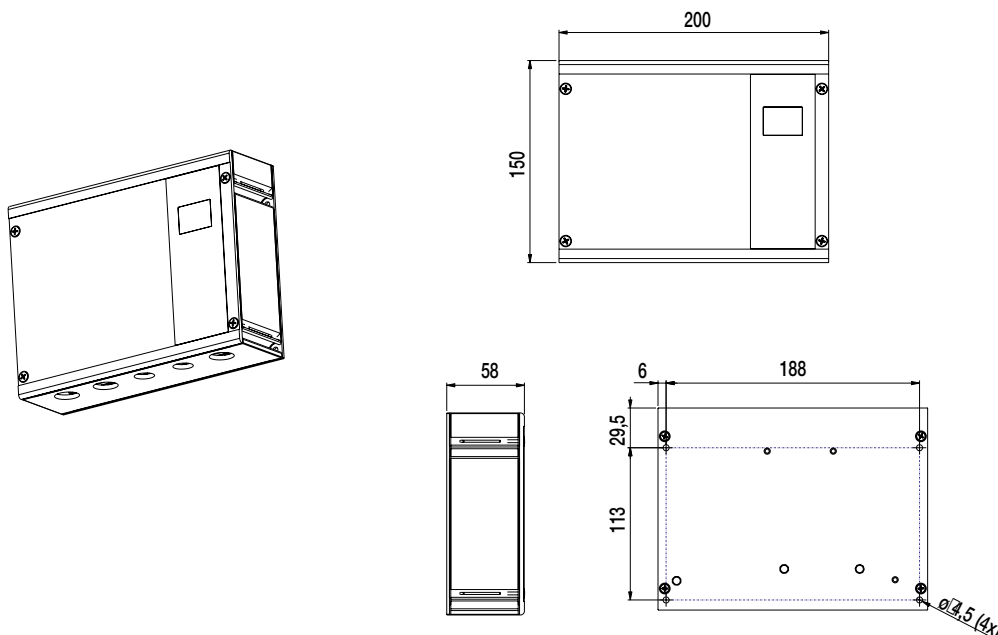

Fig. 10. Dimensions

## VARIABLE SPEED-CONTENT PUR (A, B, C, D) ROTOR SIZE 125-250

Table 8. Motor dimensions

EMX-R	F	FA	FB	FC	H	HA	HB	HD
25	82	140	12	7	81	10	173	180
35	109	140	12	7	81	10	173	180k
EMX-R	K	K1	K2	L	LA	LC	M	
25	14j6	5h9	20	114	35	152		160
35	14j6	5h9	20	141	35	179		160

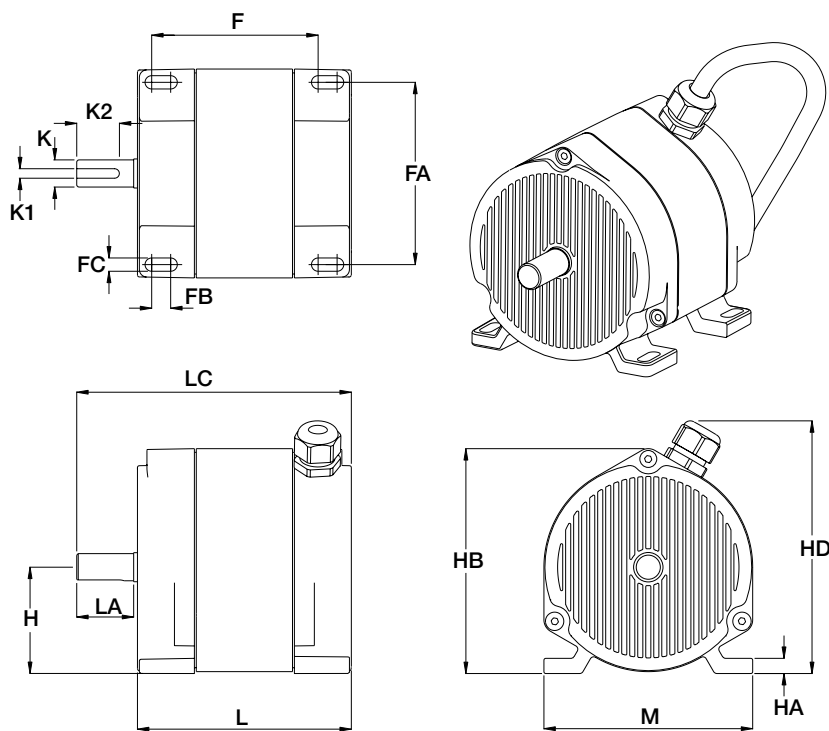

Fig. 11. Dimensions

## A HISTORY OF INNOVATION AND RELIABILITY

With more than a century of accumulated industry experience, FläktGroup is in a unique position to deliver energy efficient components and solutions for integrated performance, reliability and quality. With modern manufacturing technologies, precise deliveries and technical support, FläktGroup is your partner – fulfilling and surpassing industry standards and certifications.

» Learn more on [www.flaktgroup.com](http://www.flaktgroup.com)  
or contact one of our offices